



NUTRITION 1000W EXTRACTOR 8 PCS BLENDER

MODEL NO: PM-366





INSTRUCTION MANUAL

WARNING!

Ensure that all safety precautions are followed when using electrical appliances for the proper operation of the device. This instruction booklet describes the safety precautions to be observed during operation to prevent injuries to yourself, other persons and damage to the device. The content not only is suitable for this product but also suitable for electrical appliances in general.

SYMBOLS EXPLAINED

	For indoor use only.		Please read instruction manual and retain for future use.
	Equipment complies with the applicable EU safety requirements and regulations.		

IMPORTANT!

Do Not Use This Nutrition Extractor Blender Until You Have Read This Entire Manual Thoroughly and Keep in a safe place for future reference.

THANK YOU

FOR BEING OUR CUSTOMER

Thank you for purchasing the innovative product the PureMate Nutrition Extractor Blender
We wish you many years of health with this efficient and effective product.

SAFETY INSTRUCTIONS

Before use make sure to read all of the below instructions in order to avoid injury or damage, and to get the best results from the appliance. Make sure to keep this manual in a safe place. If you give or transfer this appliance to someone else make sure to also include this manual. In case of damage caused by user failing to follow the instructions in this manual the warranty will be void. The manufacturer accepts no liability for damages caused by failure to follow the manual, a negligent use or use not in accordance with the requirements of this manual.

- ⦿ There is a potential risk of injuries from misuse.

- ⦿ Always disconnect the appliance from the supply if it is left unattended and before assembling, disassembling or cleaning.

- ⦿ This appliance shall not be used by children. Keep the appliance and its cord out of reach of children.

- ⦿ Appliances can be used by persons with reduced physical, sensory or mental capabilities or lack of experience and knowledge if they have been given supervision or instruction concerning use of the appliance in a safe way and if they understand the hazards involved.

- ⦿ Children shall not play with the appliance.

- ⦿ If the supply cord is damaged, it must be replaced by the manufacturer, its service agent or similarly qualified persons in order to avoid a hazard.

- ⦿ Switch off the appliance and disconnect from supply before changing accessories or approaching parts that move in use.

- ⦿ Care shall be taken when handling the sharp cutting blades, emptying the bowl and during cleaning.

- ⦿ Before inserting the plug into the mains socket, please check that the voltage and frequency comply with the specifications on the rating label.

- ⦿ If an extension cord is used it must be suited to the power consumption of the appliance, otherwise overheating of the extension cord and/or plug may occur.

- ⦿ Disconnect the mains plug from the socket when the appliance is not in use and before cleaning.

- ⦿ Ensure that the mains cable is not hung over sharp edges and keep it away from hot objects and open flames.

- ⦿ Do not immerse the appliance or the mains plug in water or other liquids.
There is danger to life due to electric shock!

- ⦿ To remove the plug from the plug socket, pull the plug. Do not pull the power cord.

- ⦿ Do not touch the appliance if it falls into water. Remove the plug from its socket, turn off the appliance and send it to an authorized service center for repair.

- ⦿ Do not plug or unplug the appliance from the electrical outlet with a wet hand.

- ⦿ Never attempt to open the housing of the appliance, or to repair the appliance yourself. This could cause electric shock.

- ⦿ Children are unable to recognize the hazards associated with incorrect handling of electrical appliances. Therefore, children should never use electric household appliances unsupervised.

- ⦿ Never leave the appliance unattended during use.
- ⦿ This appliance is not designed for commercial use. Domestic use only.
- ⦿ Do not use the appliance for other than intended use.
- ⦿ Do not wind the cord around the appliance and do not bend it.
- ⦿ The use of accessory attachments not recommended by the appliance manufacturer may cause injuries or damage.
- ⦿ Do not allow children to use the blender without supervision.
- ⦿ Blade is sharp. Please be careful when you wash it.
- ⦿ Assemble the blade base with the blending cup tightly, to prevent leaks.
- ⦿ Never put the blade on the motor base directly when use.
- ⦿ Never put the hot ingredients (above 65°C) into the cups.
- ⦿ Please remove all hard kernels from the fruit before blending.
- ⦿ There is overheat protection system in the motor, it will stop working if the motor is overheated. You should turn off the power at this time and wait for the machine to cool down completely.

COMPONENTS

- 1: 1L Blending Cup
- 2: Cross Blade
- 3: Blade Base
- 4: Motor Base
- 5: 450ml Grinding Cup
- 6: Flat Blade
- 7: Blade Base
- 8: Flip-Top Lid
- 9: Storage Lid X2
- 10: Control Panel
- 11: Non-Slip Foot

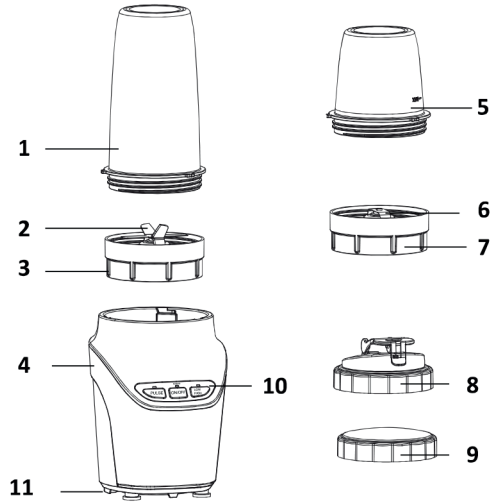

NOTE: Before using your appliance for the first time, clean all of the accessories (except for the motor base) in warm soapy water. Rinse and dry thoroughly.

OPERATING INSTRUCTIONS

Caution: Make sure the motor base is unplugged from the power source.

- ⦿ Place the motor base on a firm, flat, level surface.
- ⦿ Fill the blending cup with your ingredients and connect with the cross blade for blending purpose. Alternatively, fill the grinding cup with your ingredients and connect with the flat blade for grinding purpose. Rotate the blade base on to the cup tightly in a clockwise direction. Do not exceed the "MAX" level on the cup.
- ⦿ Rotate the cup into the motor base in clockwise direction. Make sure the cup is locked firmly.
- ⦿ Plug in the appliance.
- ⦿ Press "ON/OFF" button to turn on the unit. Press "LOW-HIGH" button once, the appliance starts working at low speed. Press it again, the appliance will work at high speed. If you want to use pulse function during operation, press the "PULSE" button once to let the appliance stop first, and then press "PULSE" button again to run the appliance with full speed for 2 seconds. Repeat if needed.
- 6. After use, press "ON/OFF" button to turn off the appliance and then unplug it.

NOTE: This product is equipped with 1 safety switch (A) on the motor base. If the blade base is not assembled correctly, the safety switch will not be activated and the machine will not work when switched on. Do not use any tools to press the safety switch in order not to cause any damage.

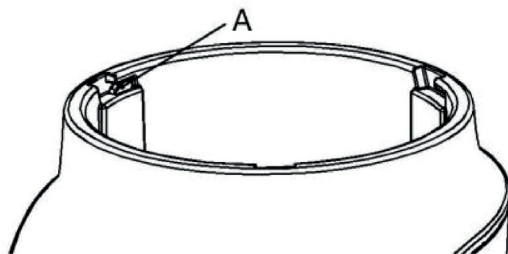

IMPORTANT!

© For blending purpose, please cut ingredients into pieces if the food is solid. Assemble the blade base with the cup tightly, otherwise it will leak. Do not blend dry solid ingredients only. After 50 seconds continuous operation of the appliance for blending, the model will stop automatically. It is required to be stopped for 5 minutes to prevent overheating. After 5 cycles, let the appliance have a rest to cool down.

© Please make sure never to put any hard objects in the blender as they could damage the blade or the cup. Please remove all hard kernels from the fruit before blending.

© The maximum weight of ingredients in the grinding cup cannot exceed 120g. After 30 seconds minute continuous operation of the appliance for grinding, it is required to be stopped for 5 minutes to prevent overheating. After 5 cycles, let the appliance have a rest to cool down.

© Pulse function can be used for ice crushing and for help with cleaning pur-pose. When crushing ice cubes, please remember to add some water into the cup.

CLEANING AND MAINTENANCE

- © Always unplug the appliance before cleaning.
- © Do not immerse the motor base in water or any other liquids. Clean it with a damp cloth and dry thoroughly.
- © Disassemble the other parts after each use and wash them in soapy water. Then rinse with clean water and dry thoroughly.
- © Only the motor base cannot be cleaned in a dishwasher. The other parts are dishwasher safe as long as the temperature is not above 60°C. You can also use the pulse function for quick cleaning if needed.
- © Do not use any parts in a microwave.

SPECIFICATIONS

Model No:	PM-366
Rated Voltage:	AC 220-240V/ 50Hz
Power Consumption:	1000W
Noise Level:	85 dB
Dimensions:	14.5X15.5X39CM
Motor Speed:	12,000 RPM (Low), 20,000RPM (High)
BPA Free:	Yes
Certifications:	Rohs, UKCA, CE
Weight:	3.0 Kgs

RECIPES

Green Healthy Smoothy

100 gr. Spinach

1 Avacado

2 Bananas

300ml Yoghurt

1. Add all the ingredients to the tall mixing cup and twist on the extractor blade
2. Lock on and mix until smooth.

Hummus

60ml chicken or vegetable stock

14oz can chickpeas (drained)

3 cloves of garlic

2tbs lemon juice

3tbs tahini (sesame paste)

1. Add all the ingredients into the tall mixing cup.
 2. Twist on the extractor blade and blend until smooth.
 3. Add salt and pepper to taste.
- Serve with warm pitta bread.

Strawberry Daiquiri

Ice

4oz daiquiri mix

2oz light rum

Handful of fresh or frozen strawberries

- ① Fill the tall mixing cup and twist on the extractor blade.
- ② Pour all the ingredients and blend until smooth.

Margrita

Ice

1½ oz tequila

1oz fresh lime juice

½ oz triple sec or Cointreau

1tsp sugar

- ⦿ Fill the tall mixing cup and twist on the extractor blade.
- ⦿ Pour all the ingredients and blend until smooth.

Classic Milkshake

Splash of milk

Few scoops of vanilla ice cream

- ⦿ Add all the ingredients into the tall mixing cup and twist on the extractor blade.
- ⦿ Blend until smooth.
- ⦿ Add more milk if you want the milk shake to be thinner.
- ⦿ To create different flavours, add different ingredients to the classic recipe, for example chocolate syrup, blueberry, strawberry, banana, peanut butter into the appliance and blend until smooth.

Ice Mocha

2 cups of coffee

2-3tbs chocolate syrup (or cocoa powder).

2 cups milk

1- 2tsp sugar (optional)

1½ cups ice

- ⦿ Brew a pot of coffee.
- ⦿ Fill the tall mixing cup with ice. Add chocolate, milk sugar then fill the cup to the top with coffee.
- ⦿ Twist on extractor blade and blend until smooth.
- ⦿ Pour into cups and serve.
- ⦿ If you want, add whipping cream to small mixing cup and blend with the milling blade for 5 seconds. Add to the top of the coffee and serve.

Strawberry Banana Smoothie

Handful of fresh or frozen strawberries

1 banana

1 cup of ice



Splash of orange juice

- ⦿ Add all the ingredients to the tall mixing cup and twist on the extractor blade.
- ⦿ Lock on and mix until smooth.

WARRANTY & SERVICE

Items purchased directly with PureMate, or one of our approved resellers, you will automatically register your warranty for 1 (ONE) year. You do not require to register again for your warranty. All warranties will execute our terms and conditions you will find these via our website at www.puremate.co.uk

DISPOSAL OF THE DEVICE

	Waste Electrical and Electronic Equipment (WEEE)	This symbol on the product and/or packaging indicates that Waste Electrical product (WEEE) under Directive 2012/19/ EU which governs used electrical and electronic appliances, should not be disposed of with general household waste.
	The Mobius Loop	This symbol indicates that the product or packaging is capable of being recycled.

FIND US ONLINE





NUTRITION 1000W EXTRACTOR 8 PCS BLENDER | Model NO: PM 366

Super Tech Health Limited
129 Shady Lane
Great Barr
Birmingham
West Midlands
B44 9ER
United Kingdom

WWW.PUREMATE.CO.UK

© Copyright 2021