

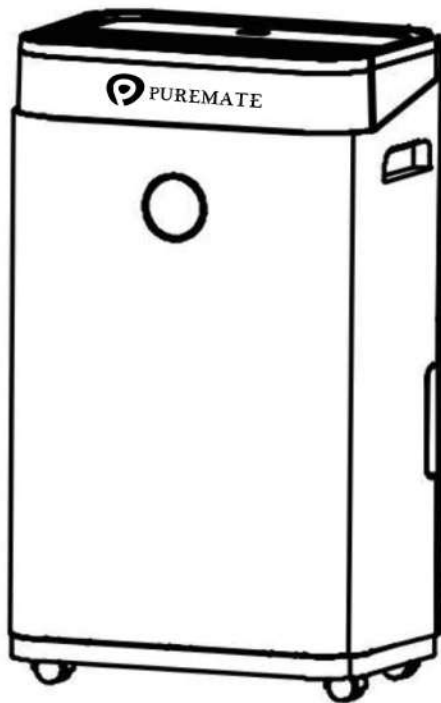

20L Dehumidifier

Model No: PM 465



INSTRUCTION MANUAL

Thank you for purchasing the innovative PureMate 20L Dehumidifier PM 465. We wish you many years of healthy indoor air with this efficient and effective product.

SAFETY GUIDELINES

- Always use the appliance only on the voltage specified.
- Never immerse the product or power cable with water or other liquids.
- Do not leave the appliance unattended around children.
- Do not insert any objects or fingers into any openings.
- Do not use around heated surfaces, open flames, flammable substances or in direct sunlight.
- Please ensure the dehumidifier is set to off when the unit is not in use.
- Please turn off and unplug the appliance before cleaning or maintenance.
- Do not operate if there are signs of damage to the cord, plug or appliance. Do not attempt to repair or adjust any electrical or mechanical functions on this unit.

Please Call Customer Service for assistance.

- Never tilt, move, or attempt to empty tank while it is operating. Ensure the dehumidifier is in an upright position.
- Never cover or restrict airflow to the dehumidifier whilst in use.
- Dispose of collected water, this is not suitable for drinking.
- When the appliance is not in use for a prolonged period, please turn it off, unplug it, pack it well, and store it in dry cool place. Please ensure water tank is always emptied before storing the dehumidifier.
- Do not run cord under throw rugs, runners, or similar coverings. Arrange cord away from traffic area and where it will not be tripped over.
- Do not use the appliance for any other purpose than its intended use, as described in the manual.
- This dehumidifier is for indoor use only. Do not use outdoors.
- Avoid the use of extension cables to prevent risk of overheating and fire risk.

- This dehumidifier may be utilized by children aged from 8 years and over and individuals with reduced physical, sensory or mental capabilities or lack of experience and knowledge how ever they must be supervised or instructed concerning use of the appliance in a safely manner and understand the hazards involved.
- Do not by any means attempt to accelerate the appliances defrosting process.
- Ensure to follow the cleaning process detailed by the manufacturer. Do not attempt to clean in any other way.
- Do not pierce, incinerate or cause damage to the appliances container of refrigerant tubing.
- Be aware that refrigerants may not contain any odour.
- The maximum refrigerants charge amount is 60g.
- In the rare occurrence the unit should malfunction, do not attempt any repairs. All repairs are required to be taken out by a professional.

Please Contact PureMate Customer Services.



Caution, risk of fire



CAUTION

Do not use appliance at temperatures below 5°C, to prevent the possibility of a heavy ice up of the evaporating coil!

PLACEMENT

1. Place the unit on a firm, level surface in an area with at least 30cm of free space around it to allow for proper air circulation.
2. Never install the unit where it could be subject to:
 - Heat sources such as radiators, heat registers, stoves or other products that produce heat.
 - In an area where oil or water may be splashed.
 - Direct sunlight
 - Mechanical vibration or shock
 - Excessive dust
 - Lack of ventilation, such as cabinet or bookcase
 - Uneven surface

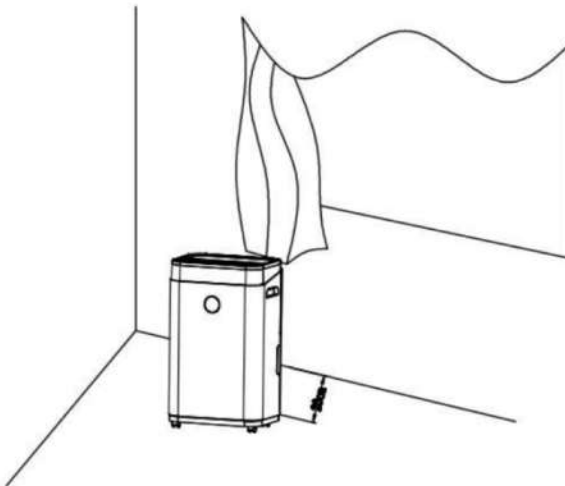

WARNING: Install the unit in rooms which exceed 4 m².

COMPONENTS

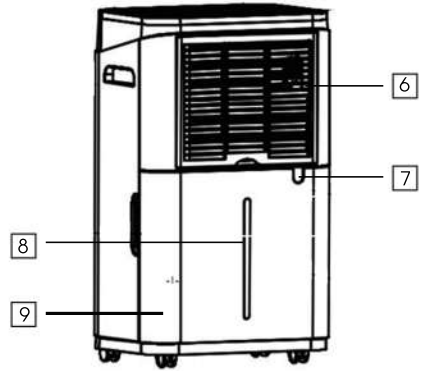
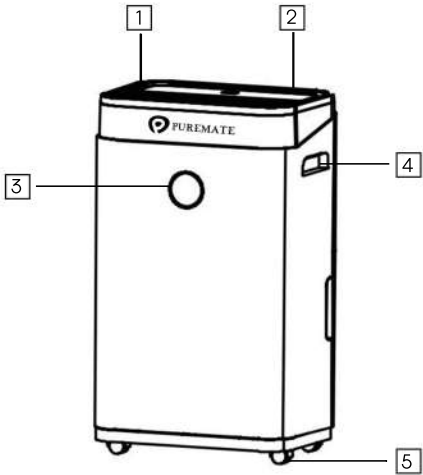

1. Air Outlet

2. Control Panel & Digital Display

3. Humidity Indicator Light

4. Handle

5. Castor Wheels

6. Air Inlet

7. Continuous Drainage Hose Connection

8. Water Level Window

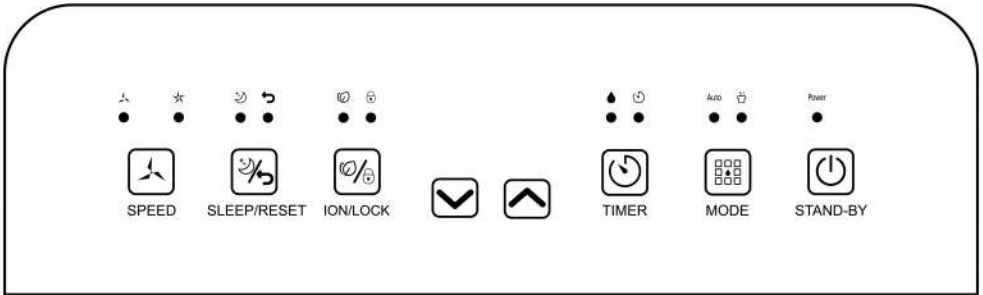

9. Water Tank

OPERATING INSTRUCTIONS







 **STANDBY BUTTON:** Press to turn ON/OFF the dehumidifier

 **MODE BUTTON:** Select between Auto and Continuous Drying Modes

- AUTO MODE: Allows manual setting of both fan speed and humidity level. Use the
-   buttons to set the desired humidity level. (Humidity range: 30-80%). Continuous Drying Mode: Automatically sets the fan to high speed and the dehumidifier run continuously. Set humidity level is disabled.

 **FAN SPEED:** Press to choose between Low and High fan speed when in Auto Mode.

 **TIMER:** Set the Timer to turn the unit ON/OFF between 00-24 hours.

- **SET THE DEHUMIDIFIER TO TURN ON:** When the dehumidifier is off, press the timer button, then use   to select the desired number of hours before you want the dehumidifier to turn on.
- **Set the dehumidifier to turn OFF:** When the dehumidifier is on, press the timer button, then use   to select the desired number of hours before you want the dehumidifier to turn off.



SLEEP MODE: Press to activate Sleep Mode. The dehumidifier automatically sets the fan to low speed, display lights turn off and the dehumidifier runs continuously.



RESET: Press and hold for 3 seconds to reset the dehumidifier. When the machine has worked for 600 hours, the pre-filter indicator light will turn on to remind you to clean the pre-filter. The machine will not work until you clean and reset the unit.



CHILD MODE: Press and hold the button for 3 seconds to lock all controls. Press and hold for 3 seconds to disable the child lock.



ION: Press to turn ON/OFF the air purifier function. (Negative Ions)

REMOVING AND EMPTYING THE WATER TANK

When the water tank full indicator illuminates and the dehumidifier beeps. The unit will automatically stop. Press the standby button before removing the water tank.

1. Gently pull the water tank out from the back of the dehumidifier.
2. Use the handle to lift, tilt and empty the water tank.
3. Once empty, insert the water tank into the correct position.
4. Do not discard the magnets and plastic rivets in the tank. Otherwise, the dehumidifier cannot be started, or the machine will not automatically stop working when the water tank is full, and the condensed water overflow will damage the floor of the room.

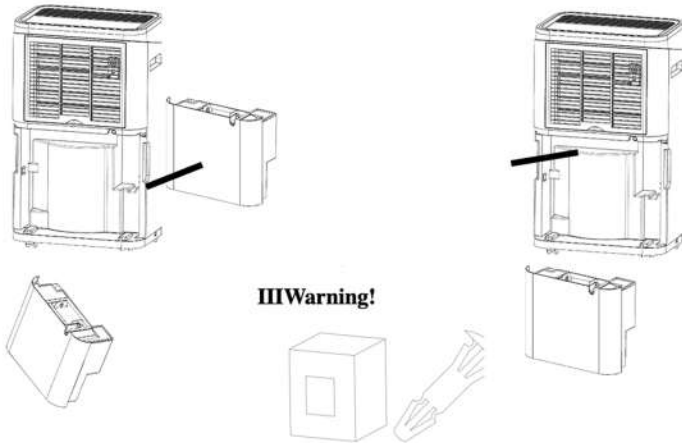

PLEASE NOTE: Your dehumidifier will not operate when the water tank is full of water or it is not set properly.

CONTINUOUS DRAINING

1. Remove water tank
2. Connect the drain hole with hose.
3. Ensure the water will always drain freely and the tube will remain in place.
4. Ensure the hose end has a suitable drainage outlet (e.g.bucket/drain)
5. Insert the water tank into the correct position.

CAUTION: DO NOT PLACE CONTINUOUS DRAINAGE HOSE OUTSIDE IN TEMPERATURES BELOW 1°C



CLEANING & MAINTENANCE

- Remove the back cover from the dehumidifier.
- Remove excess dust by patting lightly or vacuuming with the brush attachment.
- If excessively dirty, please wash with warm soapy water and rinse.

TROUBLESHOOTING		
SYMPTOM	INSPECTION	SOLUTION
The unit is not operating.	✓ Check the power connection in securely.	➤ Insert the power cord securely into the wall out let.
	✓ Check if the water level indicator lights up?	➤ Empty the water tank and reinstall correctly.
	✓ Check the room temperature.	➤ The range of operating temperature is 5-38°C.
There is little formation of condensate.	✓ Check the air filter for dirt.	➤ Clean the air filter as necessary.
	✓ Check if the air duct is blocked.	➤ To clear the obstacle.
	✓ Check if the room temperature is below 20°C.	➤ This is normal. Low humidity in low temperature environment.
	✓ Set humidity level is higher than currentHumidity value.	➤ Set the humidity level below current humidity value.
Water Leakage	✓ Overflow while moving the unit.	➤ Empty the water tank before transport.
	✓ Check if the drain hose is kinked or bends.	➤ Straighten the hose to avoid a trap existing.
Excessive Noise	✓ Check if the unit is securely positioned.	➤ Place the unit on horizontal and firm ground.
	✓ Check if any loose, vibrating parts.	➤ Secure and tight the parts.
	✓ Noise sounds like water flowing.	➤ Noise comes from flowing refrigerant. This is normal.
Error code	E2	✓ Humidity sensor dampened or failure. ➤ To clean or replace the humidity sensor.
	CL	✓ Display when Room temperature is below 5°C (41°F) . ➤ Normal. The compressor stops, and the fan keeps running.
	CH	✓ Display when Room temperature is above38°C (100°F) . ➤ Normal. The compressor stops, and the fan keeps running.
	LO	✓ Display when Room relative humidity is bellow 20%RH. ➤ Normal. The compressor stops, and the fan keeps running.
	HI	✓ Display when Room relative humidity is above 90%RH. ➤ Normal. The compressor and the fan keep running.

WARRANTY & SERVICE

This product is covered with PureMate product and labour warranty for 12 months from the date of its original purchase. If any problems occur, please contact the PureMate Customer Care Centre in your country via the contact information listed in this User Guide. We can only provide after sales service for products that are sold by PureMate or PureMate authorized retailers and distributors. If you have purchased your unit from a different place, please contact your seller for return and warranty issues.

SPECIFICATION

Model:	PM 465
Power Supply:	220 to 240V ~50Hz
Power Consumption:	370W
Water Tank Capacity:	6.5L
Working Temperature:	5°C - 32°C
Certifications:	UKCA, CE, Rohs
Warranty:	1 Year
Refrigerant:	R290
Dimensions:	34 x 24 x 57 cm
Net Weight:	14 Kg

DISPOSAL OF THIS DEVICE



At the end of the product life cycle, you should not throw this machine into the normal household garbage but bring the product to a collection point for the recycling of electrical and electronic equipment.



20L DEHUMIDIFIER | MODEL NO: PM 465

Super Tech Health Limited
129 Shady Lane
Great Barr
Birmingham
West Midlands
B44 9ER
United Kingdom

WWW.PUREMATE.CO.UK

© Copyright 2021